

# ROUGHNESS TESTER (COMPACT TYPE) CODE ISR-C200

**INSIZE PLUS**  
MADE IN EUROPE

BLUETOOTH

DATA  
OUTPUT

PROBE CAN BE CHANGED



- The product is light, reliable and durable
- 13 roughness parameters
- Can be operated by mobile phones (only Android system) or computers
- Measurement results can be exported in Excel and PDF format
- Memory of 18000 measurements with only parameters or 30 measurements with graph
- Automatic power off



probe can be set at 90°,  
for transverse measurement



probe cover (included)



adjustable stand (included)



measuring software (included), connect to mobile phones via bluetooth (only Android system) to control roughness tester, or connect to computers via USB cable or bluetooth to control roughness tester, display roughness values and curve, results can be exported in Excel and PDF format

Continued from previous page

magnetic stand adapter (included)



dial test indicator holder (optional)

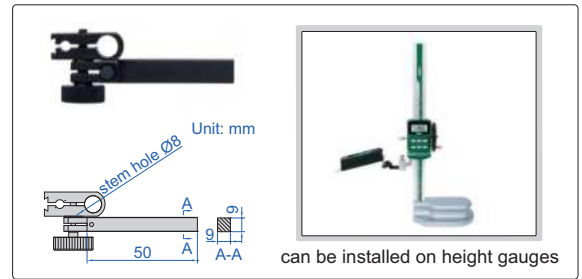

### SPECIFICATION

<b>Parameters</b>		Ra, Rq, Rt, Rz, Rc, Rmax, RSm, Rpc, Pt, R, AR, Rx, Ppc
<b>Range</b>	X axis	17.5mm
	Z axis	250µm
<b>Accuracy</b>		±(5%+0.025)µm
<b>Resolution (Ra)</b>		0.001µm
<b>Probe</b>	type	inductive
	stylus radius/angle	2µm/90°
	stylus material	diamond
<b>Measuring unit</b>		µm/µin
<b>Cut off</b>		0.25/0.8/2.5mm
<b>Number of cut-off</b>		1~5
<b>Moving speed</b>		0.5mm/s, 1mm/s
<b>Memory</b>		18000 measurements with only parameters, 30 measurements with graph
<b>Power supply</b>		built-in rechargeable battery
<b>Dimension (L×W×H)</b>		160×34×33.5mm
<b>Weight</b>		200g

### STANDARD DELIVERY

<b>Main unit</b>	1 pc
<b>Standard probe</b>	1 pc
<b>Calibration block</b>	1 pc
<b>Adjustable stand</b>	1 pc
<b>Probe cover</b>	1 pc
<b>Magnetic stand adapter</b>	1 pc
<b>Software and USB cable</b>	1 pc
<b>AC/DC adapter</b>	1 pc

### OPTIONAL ACCESSORY

<b>Dial test indicator holder</b>	<b>6293-6</b>
<b>Groove probe</b>	<b>ISR-C200-SB21</b>
<b>Small hole probe</b>	<b>ISR-C200-SB31</b>
<b>Deep groove probe</b>	<b>ISR-C200-SB121</b>
<b>Extension rod</b>	<b>ISR-C200-ER50</b>
<b>Extension rod</b>	<b>ISR-C200-ER100</b>

### SPECIFICATION OF PROBES

Unit: mm

<p><b>standard probe (included)</b></p> <p>measurement for plane surfaces, also transverse measurement for plane surfaces, cylinders and grooves</p>	<p><b>groove probe (optional), code ISR-C200-SB21</b></p> <p>measure plane surfaces and grooves</p>
<p><b>small hole probe (optional), code ISR-C200-SB31</b></p> <p>measure holes with diameter &gt; Ø4mm and depth &lt; 20mm</p>	<p><b>deep groove probe (optional), code ISR-C200-SB121</b></p> <p>measure grooves with depth &lt; 20mm</p>
<p><b>extension rod (optional), code ISR-C200-ER50</b></p> <p>for long holes</p>	<p><b>extension rod (optional), code ISR-C200-ER100</b></p> <p>for long holes</p>

# ROUGHNESS TESTER CODE ISR-C002

BLUETOOTH

DATA  
OUTPUT

CAN BE OPERATED BY  
MOBILE PHONES OR COMPUTERS



- Roughness tester can be operated by mobile phones (only Android system) or computers
- Data can be sent to Excel by connecting to computers via bluetooth or SPC cable
- Support bluetooth printer
- 21 roughness parameters
- Display roughness value, profile and curve
- Memory of maximum 100 results
- Automatic power off



software flash disk (included)

screen display



measurement result



roughness profile



Rmr analysis

probe cover (included)



put the small workpieces directly under the probe for measurement



adjustable stand (included)



operate roughness tester by mobile phones



connect to mobile phones via bluetooth (only Android system), display roughness values, profile and curve

operate roughness tester by computers



connect to computers via USB cable (software is included), display roughness values, profile and curve

data can be sent to Excel by connecting to computer via bluetooth or SPC cable

via bluetooth

receiver (optional)



via SPC cable

SPC cable (optional)



receiver (optional)



bluetooth printer (optional)



To be continued

Continued from previous page

Unit: mm

light duty test stand (optional)



heavy duty test stand (optional)



<p><b>extension rod (optional), code ISR-C002-ER</b></p>	<p><b>transverse rod (optional), code ISR-C002-TR</b></p>
<p><b>tiny hole probe (optional), code ISR-C002-SBP</b></p>	<p><b>deep groove probe (optional), code ISR-C002-DGP</b></p>
<p><b>deep groove probe (optional), code ISR-C002-DGP1</b></p>	

**SPECIFICATION**

<b>Parameters</b>	Ra, Rz, Rq, Rv, Rp, RS, R3z, R3y, Rt, Rz (JIS), Rk, Rku, Rsm, Rpc, Rpk, Rvk, Rsk, Mr1, Mr2, Ry (JIS), Rmax	
<b>Range</b>	320µm (-160µm~160µm)	
<b>Accuracy</b>	±10%	
<b>Resolution (Ra)</b>	0.001µm	
<b>Probe</b>	<b>type</b>	inductive
	<b>stylus radius/angle</b>	5µm/90°
	<b>stylus material</b>	diamond
<b>Measuring force</b>	4mN	
<b>Measuring unit</b>	µm/µin	
<b>Cut off</b>	0.25/0.8/2.5mm	
<b>Number of cut-off</b>	1 to 5	
<b>Moving speed</b>	0.5mm/s, 1mm/s	
<b>Memory</b>	100 measurement results	
<b>Output</b>	bluetooth and USB	
<b>Power supply</b>	built-in rechargeable battery	
<b>Dimension (L×W×H)</b>	141×55×40mm	
<b>Weight</b>	400g	

**STANDARD DELIVERY**

<b>Main unit</b>	1 pc
<b>Standard probe</b>	1 pc
<b>Calibration block and support</b>	1 pc of each
<b>Adjustable stand</b>	1 pc
<b>Probe cover</b>	1 pc
<b>Software and USB cable</b>	1 pc
<b>AC/DC adapter</b>	1 pc

**OPTIONAL ACCESSORY**

<b>Extension rod</b>	ISR-C002-ER
<b>Transverse rod</b>	ISR-C002-TR
<b>Tiny hole probe</b>	ISR-C002-SBP
<b>Deep groove probe</b>	ISR-C002-DGP
<b>Deep groove probe</b>	ISR-C002-DGP1*
<b>Light duty test stand</b>	ISR-C002-STAND1
<b>Heavy duty test stand</b>	ISR-C002-STAND
<b>Bluetooth printer</b>	ISR-C002-PRINTER
<b>Receiver</b>	ISR-C300-RECEIVER
<b>SPC cable</b>	ISR-C300-SPC

\*Need to be delivered with roughness tester ISR-C002

## ROUGHNESS TESTER (SEPARABLE TYPE)

BLUETOOTH

TOUCH SCREEN

CAN BE OPERATED BY COMPUTERS OR MOBILE PHONES

DATA OUTPUT



POPULAR MODEL

- Roughness tester can be operated by mobile phones or computers
- Data can be sent to Excel via connecting to computers via bluetooth or SPC cable
- Support bluetooth printer
- 22 roughness parameters
- Meet ISO, DIN, ANSI, JIS standards
- Display roughness values, profile and curve
- Memory of maximum 100 data and waveform
- Built-in lithium battery, working time more than 50 hours
- Touch screen
- Automatic power off



ISR-C300

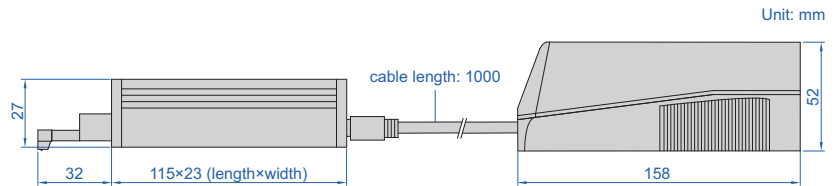

roughness tester screen display

Ra 23-05-24 12:26:27 2.50mm x 5 D-P

Ra= 4.203μm	Rz= 59.308μm
Rq= 5.989μm	Rt= 230.72μm
Rp= 45.824μm	Rv= 13.484μm
R3z= 5.83μm	R3y= 22.47μm

measurement result

---

Lt=1.50mm(0.25\*5) 00:00:00

R [LC ISO 16610-21] PC-RC

Pickup:001μ

Ra= 0.000μm	Rz= 0.000μm
-------------	-------------

roughness profile

---

Ra 23-05-24 12:26:27 2.50mm x 5 D-P

C (Rt)	Rmr
5%	0.0%
10%	0.0%
15%	0.0%
20%	0.0%

Rmr analysis



probe and main unit can be combined together

operate roughness tester by mobile phones



connect to mobile phones via bluetooth display roughness values, profile and curve



software flash disk (included)

operate roughness tester by computers

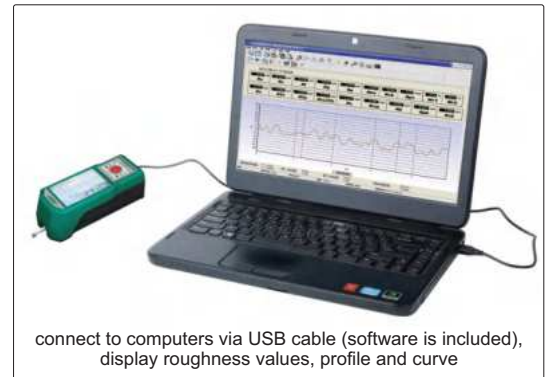

connect to computers via USB cable (software is included), display roughness values, profile and curve



bluetooth printer (optional)

To be continued

Continued from previous page

data can be sent to Excel by connecting to computer via bluetooth or SPC cable

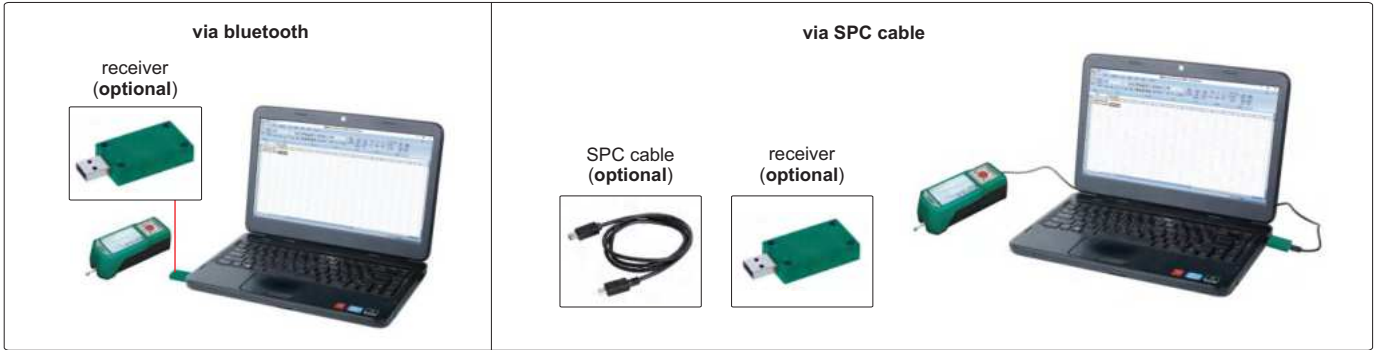

probe support (optional)

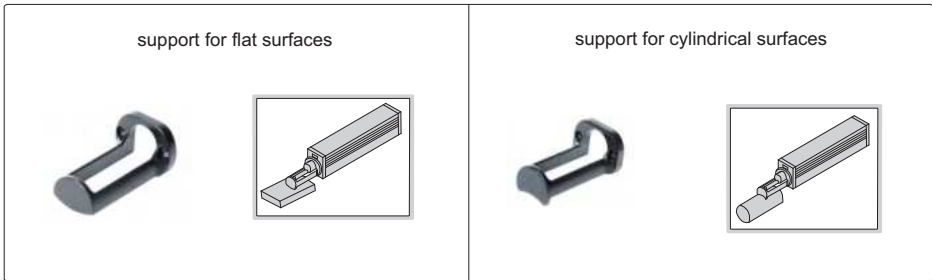

adjustable stand (included)



magnetic stand adapter (included)

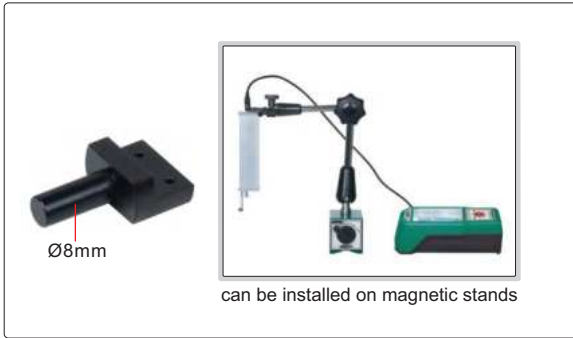

height gauge adapter (optional)



**NOTE:** Please check whether the adapter can fit your height gauges. When using **INSIZE** height gauges, please use the dial test indicator holder of height gauges

light duty test stand (optional)



heavy duty test stand (optional)



To be continued

Continued from previous page

optional probes

Unit: mm

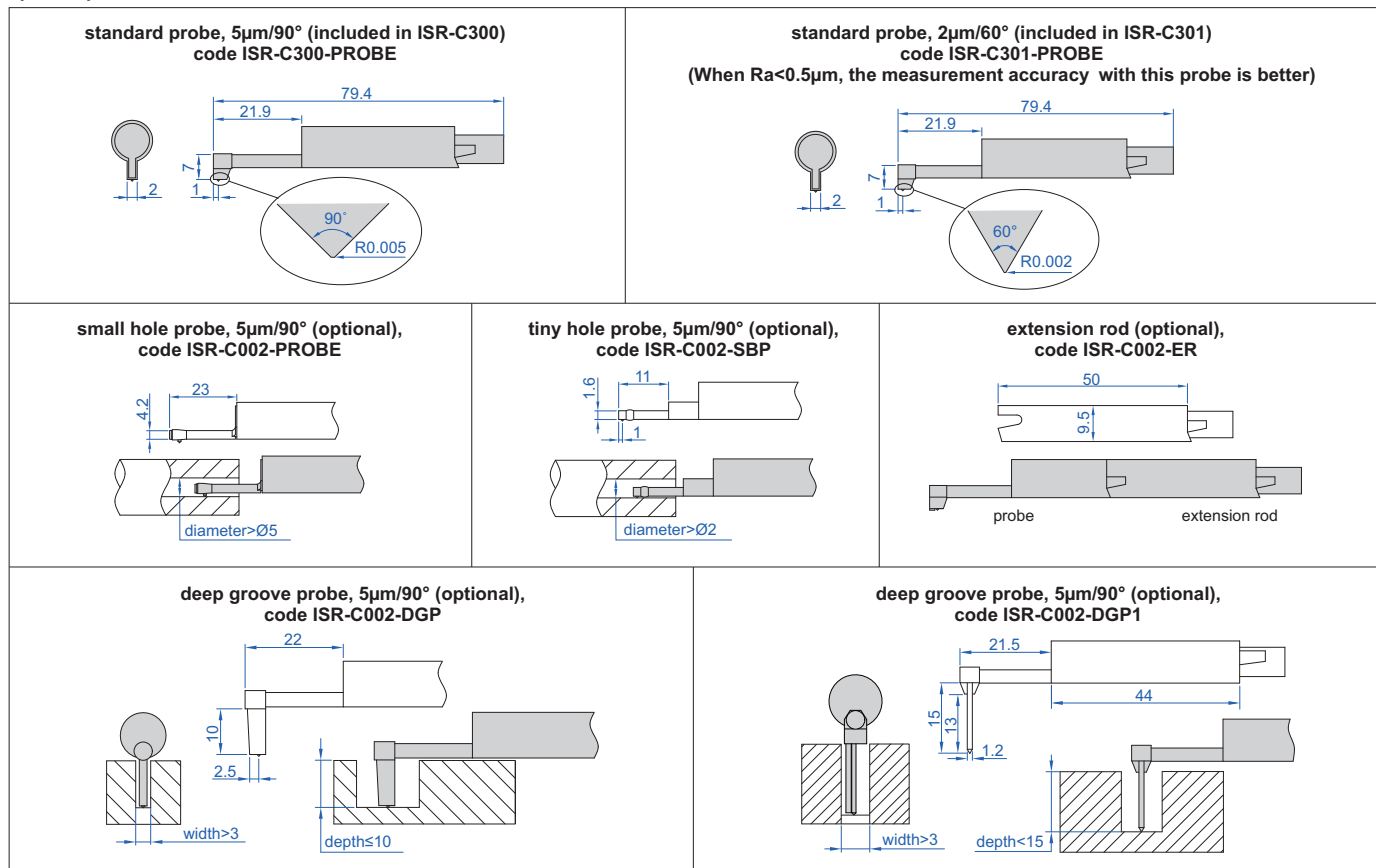

## SPECIFICATION

Code	ISR-C300	ISR-C301
Measuring force	4mN	0.75mN
Stylus radius/angle	5µm/90°	2µm/60°
Parameters	Ra, Rz, Rq, Rv, Rp, Rs, R3z, R3y, Rt, Rc, Rz (JIS), Rk, Rku, Rsm, Rpc, Rpk, Rvk, Rsk, Mr1, Mr2, Ry, Rmax	
Probe type	inductive	
Stylus material	diamond	
Range	X axis	17.5mm
	Z axis	320µm (-160µm~160µm)
Accuracy	±10%	
Resolution (Ra)	0.001µm	
Measuring unit	µm/µin	
Cut off	0.25/0.8/2.5mm	
Number of cut-offs	1~5	
Moving speed	0.135mm/s, 0.5mm/s, 1mm/s	
Memory	100 measurement results	
Output	USB and bluetooth	
Power supply	built-in rechargeable battery	
Dimension (L×W×H)	158×64×52mm	
Weight	400g	

## STANDARD DELIVERY

Main unit	1 pc
Standard probe (included in ISR-C300)	1 pc
Standard probe (included in ISR-C301)	1 pc
Calibration block and support	1 pc of each
Connecting cable (long and short)	1 pc of each
Magnetic stand adapter	1 pc
Adjustable stand	1 pc
Touch pen	1 pc
Software and USB cable	1 pc
AC/DC adapter	1 pc

## OPTIONAL ACCESSORY

Extension rod	ISR-C002-ER
Small hole probe	ISR-C002-PROBE
Tiny hole probe	ISR-C002-SBP
Deep groove probe	ISR-C002-DGP
Deep groove probe	ISR-C002-DGP1*
Standard probe	ISR-C301-PROBE
Standard probe	ISR-C300-PROBE
Bluetooth printer	ISR-C002-PRINTER
Height gauge adapter	ISR-C300-LB1
Receiver	ISR-C300-RECEIVER
SPC cable	ISR-C300-SPC
Support for flat surface	ISR-C300-COVER1
Support for cylindrical surface	ISR-C300-COVER2
Light duty test stand	ISR-C002-STAND1
Heavy duty test stand	ISR-C002-STAND

\*Need to be delivered with roughness tester **ISR-C300**

DATA OUTPUT

BLUETOOTH

TOUCH SCREEN

CAN BE OPERATED BY MOBILE PHONES OR COMPUTERS

## ROUGHNESS TESTER CODE ISR-T120



- Roughness tester can be operated by mobile phones (only Android system) or computers
- Data can be sent to Excel by connecting to computers via bluetooth or SPC cable
- Built-in printer can print measurement results and graphics
- 22 roughness parameters
- Meet ISO, DIN, ANSI, JIS standards
- Display roughness values, profile and curve
- Memory of maximum 100 data and waveform
- Built-in lithium battery, working time more than 50 hours
- Automatic power off

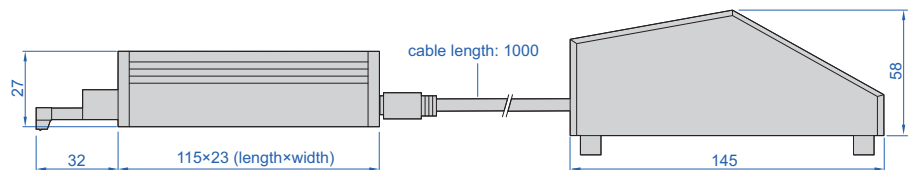
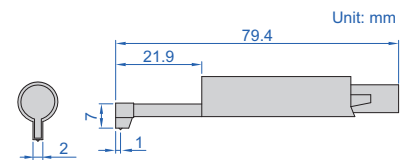

roughness tester screen display

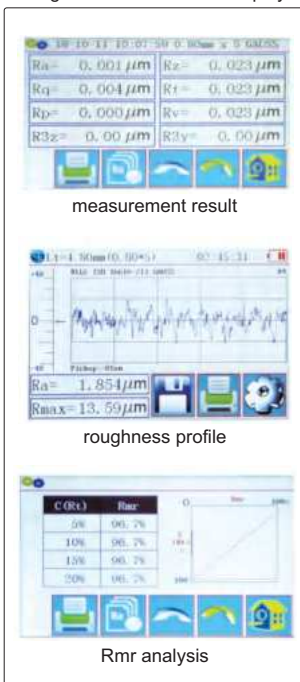

operate roughness tester by mobile phones



operate roughness tester by computers

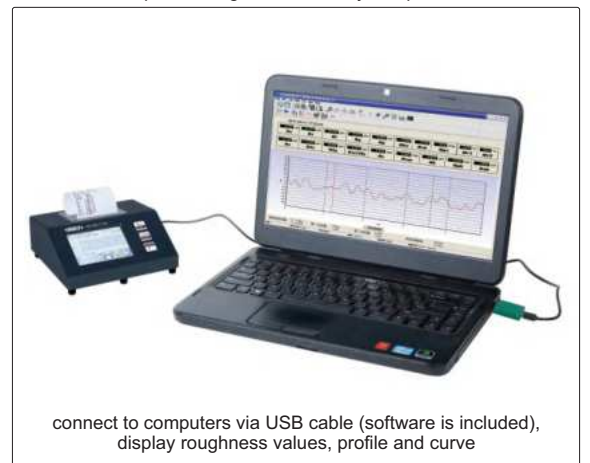



To be continued



Continued from previous page

data can be sent to Excel by connecting to computer via bluetooth or SPC cable

<p><b>via bluetooth</b></p> <p>receiver (optional)</p> 	<p><b>via SPC cable</b></p> <p>SPC cable (optional)</p>  <p>receiver (optional)</p> 
--	---

probe support (optional)

support for cylindrical surface

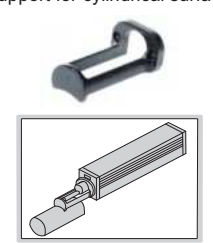

support for flat surface

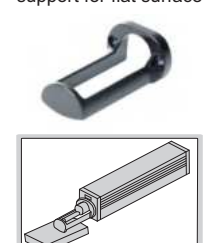

height gauge adapter (optional)



9x9mm



can be installed on height gauges

magnetic stand adapter (included)



Ø8mm



can be installed on magnetic stands

**NOTE:** Please check whether the adapter can fit your height gauges. When using **INSIZE** height gauges, please use the dial test indicator holder of height gauges

optional probes

Unit: mm

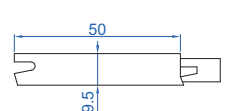
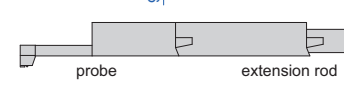
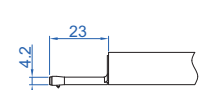
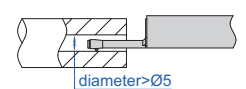
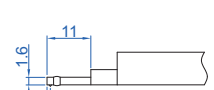
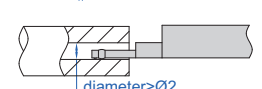
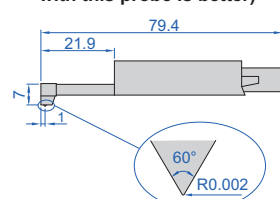
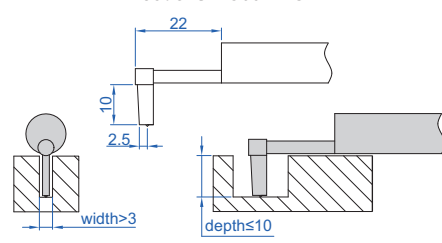
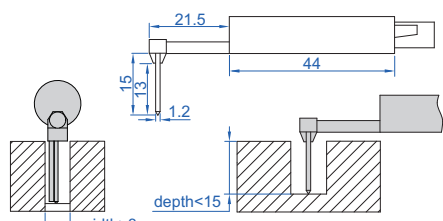
<p><b>extension rod (optional), code ISR-C002-ER</b></p>  <p>50 9.5</p>  <p>probe      extension rod</p>	<p><b>small hole probe (optional), code ISR-C002-PROBE</b></p>  <p>23 4.2</p>  <p>diameter &gt; Ø5</p>	<p><b>tiny hole probe (optional), code ISR-C002-SBP</b></p>  <p>11 1.6 1</p>  <p>diameter &gt; Ø2</p>
<p><b>2µm/60° probe (optional), code ISR-C300-P2UM</b> (When Ra &lt; 0.5µm, the accuracy with this probe is better)</p>  <p>79.4 21.9 1 60° R0.002</p>	<p><b>deep groove probe (optional), code ISR-C002-DGP</b></p>  <p>22 10 2.5 width &gt; 3 depth ≤ 10</p>	<p><b>deep groove probe (optional), code ISR-C002-DGP1</b></p>  <p>44 21.5 15 13 1.2 width &gt; 3 depth &lt; 15</p>

To be continued

Continued from previous page

light duty test stand (optional)



heavy duty test stand (optional)



### SPECIFICATION

<b>Parameters</b>		Ra, Rz, Rq, Rv, Rp, Rs, R3z, R3y, Rt, Rc, Rz (JIS), Rk, Rku, Rsm, Rpc, Rpk, Rvk, Rsk, Mr1, Mr2, Ry, Rmax
<b>Range</b>	<b>X axis</b>	17.5mm
	<b>Z axis</b>	640µm (-320µm~320µm)
<b>Accuracy</b>		±10%
<b>Resolution (Ra)</b>		0.001µm
<b>Probe</b>	<b>type</b>	inductive
	<b>stylus radius/angle</b>	5µm/90°
	<b>stylus material</b>	diamond
<b>Measuring force</b>		4mN
<b>Measuring unit</b>		µm/µin
<b>Cut off</b>		0.25/0.8/2.5mm
<b>Number of cut-offs</b>		1~5
<b>Traverse speed</b>		0.135mm/s, 0.5mm/s, 1mm/s
<b>Memory</b>		100 measurement results
<b>Output</b>		bluetooth and USB
<b>Power supply</b>		built-in rechargeable battery
<b>Dimension (L×W×H)</b>		155×145×58mm
<b>Weight</b>		1000g

### STANDARD DELIVERY

<b>Main unit</b>	1 pc
<b>Standard probe</b>	1 pc
<b>Calibration block and support</b>	1 pc of each
<b>Magnetic stand adapter</b>	1 pc
<b>Adjustable stand</b>	1 pc
<b>Touch pen</b>	1 pc
<b>Software and USB cable</b>	1 pc
<b>AC/DC adapter</b>	1 pc

### OPTIONAL ACCESSORY

<b>Extension rod</b>	ISR-C002-ER
<b>Small hole probe</b>	ISR-C002-PROBE
<b>Tiny hole probe</b>	ISR-C002-SBP
<b>2µm/60° probe</b>	ISR-C300-P2UM
<b>Deep groove probe</b>	ISR-C002-DGP
<b>Deep groove probe</b>	ISR-C002-DGP1 *
<b>Height gauge adapter</b>	ISR-C300-LB1
<b>Receiver</b>	ISR-C300-RECEIVER
<b>SPC cable</b>	ISR-C300-SPC
<b>Support for flat surface</b>	ISR-C300-COVER1
<b>Support for cylindrical surface</b>	ISR-C300-COVER2
<b>Light duty test stand</b>	ISR-C002-STAND1
<b>Heavy duty test stand</b>	ISR-C002-STAND

\*Need to be delivered with roughness tester ISR-T120

## ROUGHNESS TESTER (BASIC TYPE) CODE ISR-C003

- Unit:  $\mu\text{m}$ ,  $\mu\text{in}$
- Automatic power off

ATTENTION: THIS ROUGHNESS TESTER IS NOT SUITABLE FOR ROUGH TURNING, MILLING AND PLANING WORKPIECES



### SPECIFICATION

Parameters*		Ra, Rz, Rq, Rt
Range		Ra, Rq: 0.05~15 $\mu\text{m}$ Rz, Rt: 0.1~50 $\mu\text{m}$
Accuracy		$\pm 10\%$
Resolution (Ra)		0.01 $\mu\text{m}$
Probe	type	piezoelectric
	stylus radius/angle	10 $\mu\text{m}/90^\circ$
	stylus material	diamond
Measuring force		5mN
Measuring unit		$\mu\text{m}/\mu\text{in}$
Cut off		0.25/0.8/2.5mm
Evaluation length		1.25mm for cut off 0.25mm 4mm for cut off 0.8mm 5mm for cut off 2.5mm
Moving speed		0.75mm/s
Power supply		built-in rechargeable battery
Dimension (L×W×H)		106×70×24mm
Weight		200g

\* Rmax parameter can be customized

### STANDARD DELIVERY

Main unit	1 pc
Calibration block	1 pc
AC/DC adapter	1 pc



fixture for small shafts (optional)



clamping range:  
 $\varnothing 3\sim 20\text{mm}$

application



calibration block (included)

### OPTIONAL ACCESSORY

Fixture for small shafts

ISR-C003-FIXTURE

## SURFACE ROUGHNESS SPECIMEN SET CODE ISR-CS130-W

**INSIZE PLUS**  
MADE IN EUROPE

- For checking, identifying and specifying the roughness by symbol
- Rust-proof, made of pure Nickel



Machining method	Roughness (Ra) *	Roughness (Rz) *	Quantity
Flat lapping	0.05, 0.1, 0.2 $\mu\text{m}$	0.55, 1, 1.6 $\mu\text{m}$	3 pcs
	2, 4, 8 $\mu\text{in}$		
Reaming	0.4, 0.8, 1.6 $\mu\text{m}$	3, 6, 10 $\mu\text{m}$	3 pcs
	16, 32, 63 $\mu\text{in}$		
Plain grinding	0.05, 0.1, 0.2, 0.4, 0.8, 1.6 $\mu\text{m}$	0.55, 1, 1.6, 3, 6, 10 $\mu\text{m}$	6 pcs
	2, 4, 8, 16, 32, 63 $\mu\text{in}$		
Horizontal milling	0.4, 0.8, 1.6, 3.2, 6.3, 12.5 $\mu\text{m}$	2.5, 4, 8, 16, 32, 50 $\mu\text{m}$	6 pcs
	16, 32, 63, 125, 250, 500 $\mu\text{in}$		
Vertical milling	0.4, 0.8, 1.6, 3.2, 6.3, 12.5 $\mu\text{m}$	2.5, 4, 8, 16, 32, 50 $\mu\text{m}$	6 pcs
	16, 32, 63, 125, 250, 500 $\mu\text{in}$		
Turning	0.4, 0.8, 1.6, 3.2, 6.3, 12.5 $\mu\text{m}$	2.5, 4, 8, 16, 32, 50 $\mu\text{m}$	6 pcs
	16, 32, 63, 125, 250, 500 $\mu\text{in}$		

\* The actual value is the value to be calibrated